

GULF MECHANICAL ACOUSTIC MANUFACTURING COMPANY

**GMAMCO**

CD SERIES AIR/SMOKE CONTROL DAMPERS

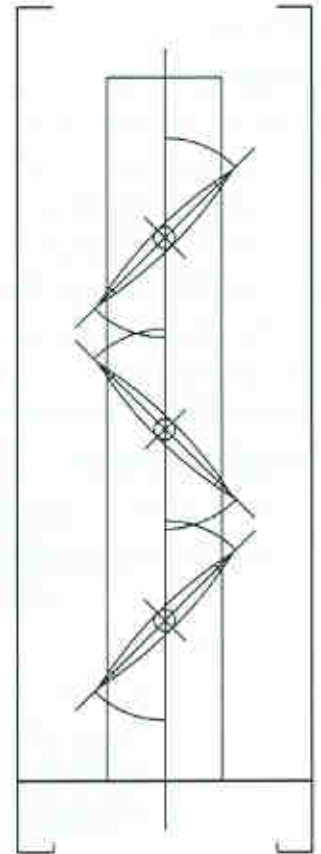
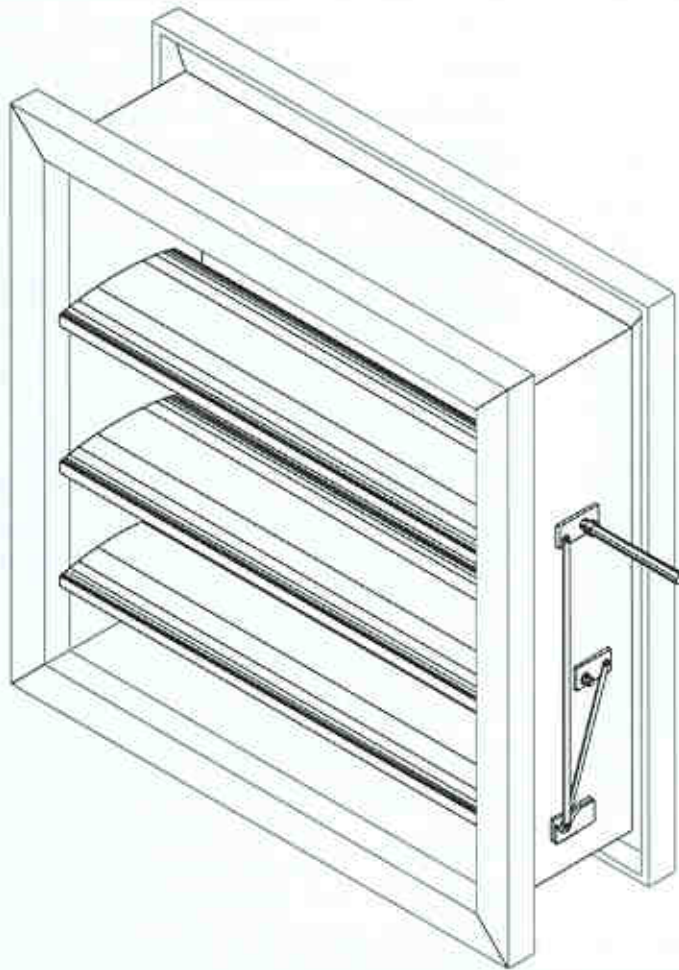

### Application

The damper is suitable for systems requiring air / smoke control, system balancing and shut-off.

### Features

The CD Air / Smoke Control Damper is constructed using double skin interlocking aerofoil blades, which in conjunction with stainless steel side seals provide positive control and shut off. A multiblade opposed action format utilizes a fully enclosed linkage system which is located outside of the airstream, to ensure the minimum ingress of airborne contaminants.



## **STANDARD CONSTRUCTION**

### **Frame**

The damper frame is made from 1.0mm / 1.2 mm / 1.6 mm Galvanised mild steel / Stainless Steel, according to the specification. Galvanised sheet metal conforms to ASTM A653/A653M. Coating Designation G 90/Z 275. Stainless Steel confirms to 304 / 316L as required.

### **Damper Blades**

Double skin aerofoil section Galvanised mild Steel / Aluminium / Stainless Steel blades each section manufactured from Ga. 22. Galvanised sheet metal conforms to ASTM A653 / A653M. Coating Designation G 90/Z 275. The blades are linked to give opposed blade rotation. For low leakage application the blade shall be supplied with rubber seal.

### **Manual Operation**

Manual operation is via a Lockable manual lever and quadrant assembly, manufactured in alloy.

### **Blade Side Seal**

The side seal provide low leakage characteristics. It is manufactured from Stainless Steel Grade 316.

### **Linkage and Shafts**

#### **Tie bars**

Zinc plated mild steel / Stainless Steel tie bars 12mm x 3 mm punched to fit onto zinc plated drive pins.

#### **Shafts**

Zinc plated mild steel / Stainless Steel drive shafts 12 mm diameter to ensure smooth low friction rotation.

#### **Bearings**

Oilite bronze bearings impregnated with mineral oil to ISO VG 100 (SAE 30) with wall thickness up to 3mm to ensure low friction rotation of drive shafts.

#### **Finish**

Mill

#### **Sealant**

All seams and joints are sealed with sealant conforming to the dictates of DW 144.

## **Application Parameters**

CD dampers of maximum width and height are suitable for system pressure upto 1000Pa, and duct velocity up to 10 m/s

With the Silicone Seals the damper shall be used for operating temperature up to 300°C.

CD dampers are designed for application in normal dry filtered air systems. When exposed to fresh air intakes and / or inclement conditions, the dampers should subject to a planned inspection and maintenance programme.

## **Size parameters**

### *Single Modules*

Width from 100 mm - 1200 mm

Heights from 100 mm - 1200 mm

### *Multiple Width Configuration*

Available as 2 single units, up to a maximum of 2480mm wide. Multiple dampers are driven from each side.

### *Multiple Height Configuration*

Unlimited height.

For very large assemblies, additional support may be required.

## **Variations**

Variations to our standard construction are available at additional cost.

They include :

- Factory installed electric actuators
- Frame mounting bracket for simple field installations of most actuators.
- Horizontal frame mounting bracket
- Blades with silicone seals to withstand temperature up to 300°C.

# CD Series Control Options

## Option H Manual

Lockable manual lever and quadrant Assembly, manufactured in alloy.

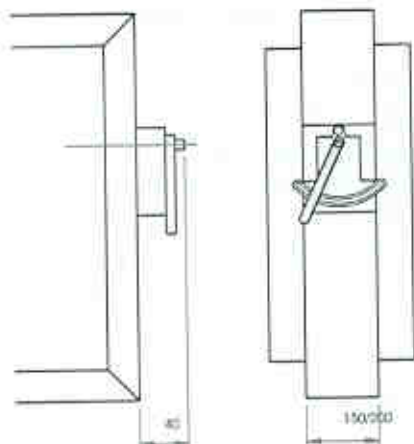
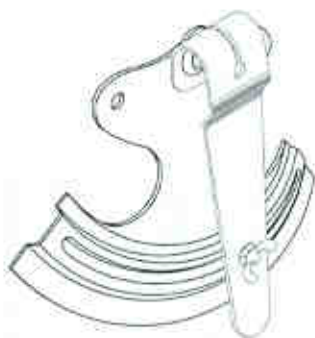

## Option B Motor Bracket

12 mm dia. Shaft extended 100mm through the casing, with universal motor mounting plate pre-drilled to accept the site-fitted actuators. Horizontally mounted versions supplied only to order.

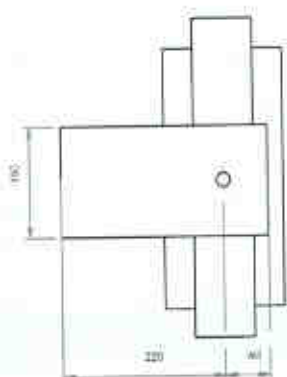
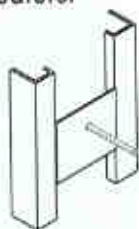

## Option M Electric

Factory fitted and bench tested electric motors. Please state type and voltage of actuator required. Horizontally mounted version supplied only to order. Dimensions subject to type of Actuator.

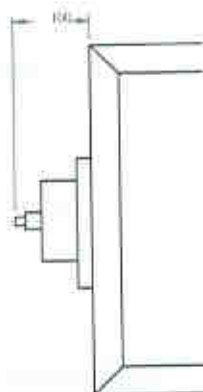
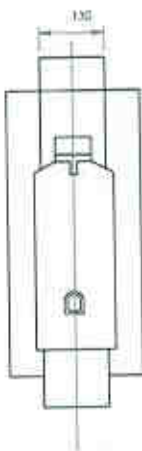
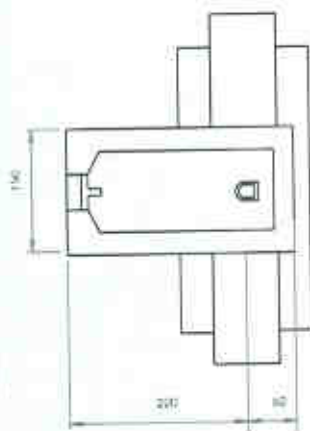
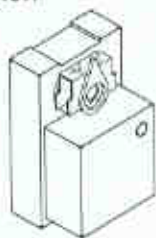

## Multiple Assemblies

It may be necessary to manufacture multiple module units so as to supply the required dimension. The variants illustrated are a selection of what may be supplied. The "four-in-line" units illustrated would be supplied with blades being vertically mounted.

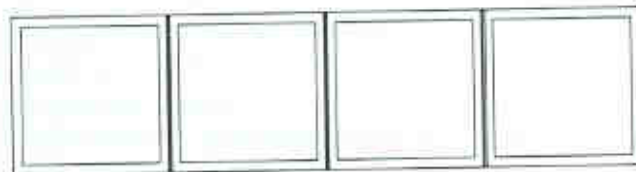
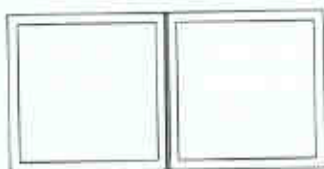
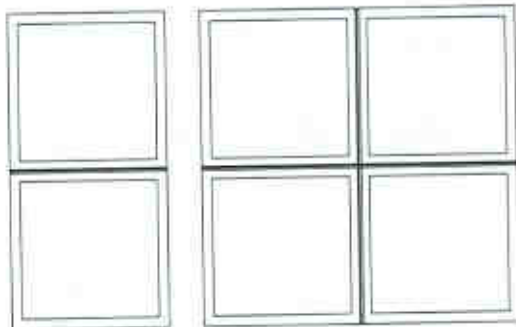

# CD Series

## Performance Characteristics and Torque Chart

OPEN PRESSUER DROP CURVE

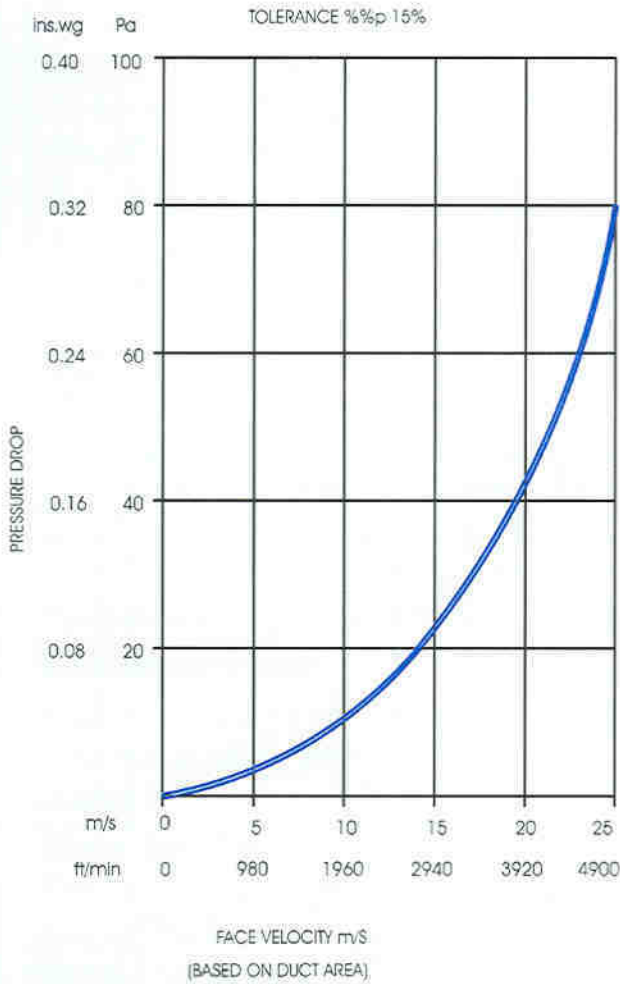

LEAKAGE CURVE (BLADES CLOSED)

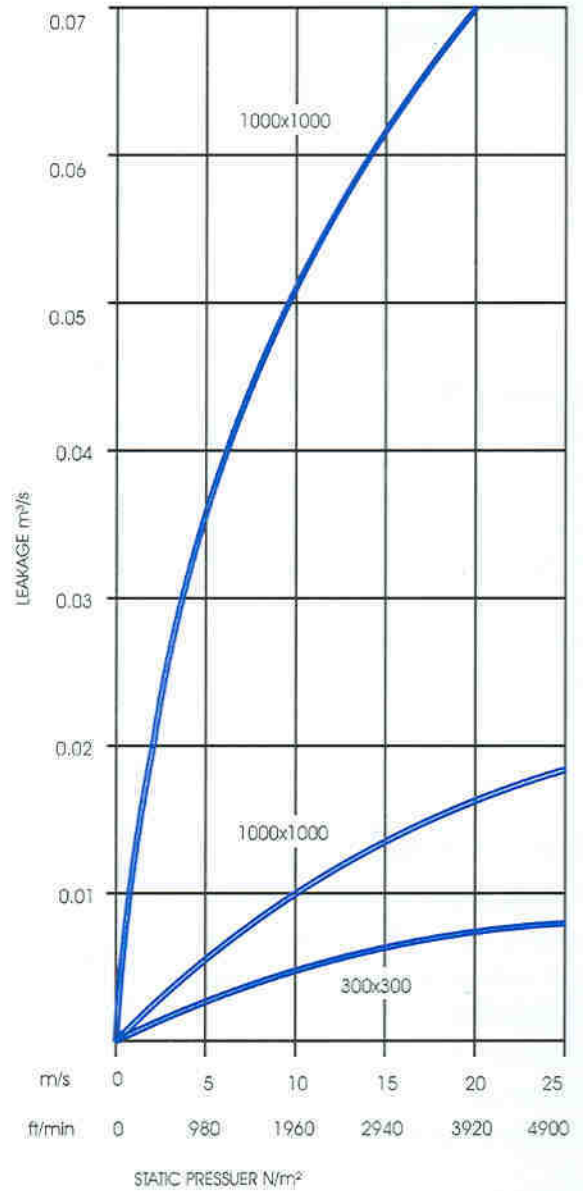

### Torque Chart

Duct Pressure (Pa)	Weight x Height (mm)					
	200 x 200		500 x 500		1000 x 1200	
	Nm	lb/ins	Nm	lb/ins	Nm	lb/ins
250	2	18	5	44	10	88
500	3	26	6	53	11	97
750	4	35	7	62	13	115
1000	5	44	8	71	15	132

The above values have been rounded up and down and are therefore approximate only. The torque calculated during rotation of the blades is less than the total torque calculated during blade lock. When motorizing multi-sections, please allow 10% extra capacity to compensate incurred resistances.

## Weight Chart

All references are in kilograms and are approximate values for 150mm length damper only. For others please contact GMAMCO.

Damper size (mm)	Square / Rectangular Solgot Models Width (mm)									
	100	200	300	400	500	600	700	800	900	1000
Height(mm)										
100	2	3	4	5	6	7	8	9	10	11
200	3	4	5	6	7	8	10	10	11	13
300	4	5	6	7	8	9	10	10	11	13
400	6	7	8	9	10	11	11	12	13	14
500	7	8	9	11	11	12	13	14	15	16
600	7	9	11	12	12	13	14	15	17	17
700	8	10	12	13	14	15	16	17	19	19
800	10	11	13	14	15	16	18	19	20	21
900	12	12	14	15	17	17	19	21	22	23
1000	13	14	15	16	17	18	20	23	24	26

Please Note: These values have been rounded "up or down" to whole values and are therefore illustrated for estimation purposes only.

## CD Series - Technical Data

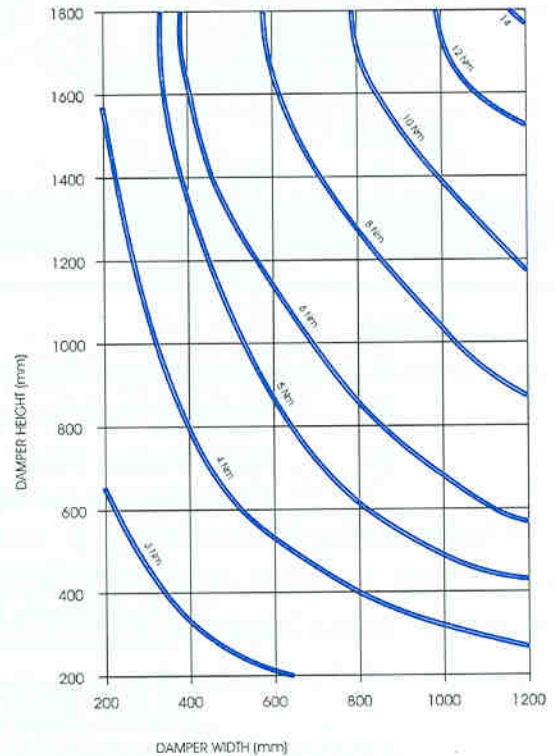
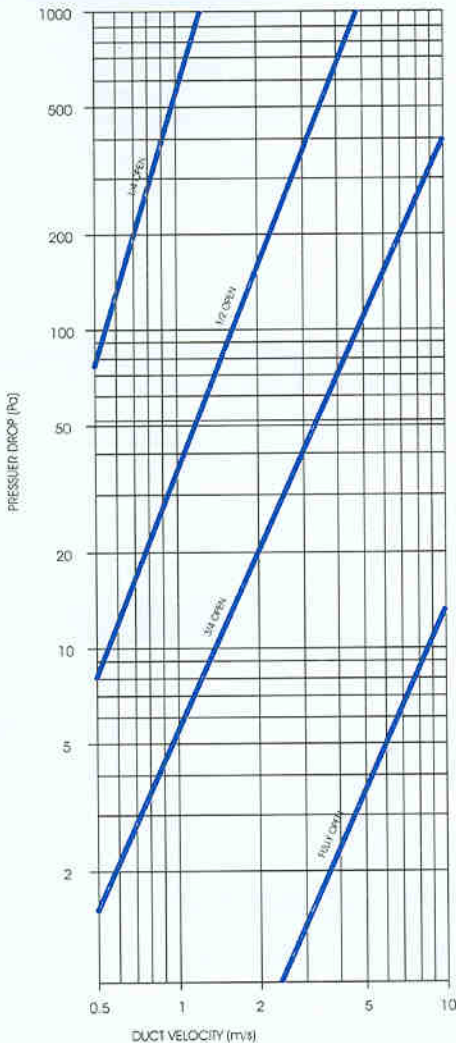

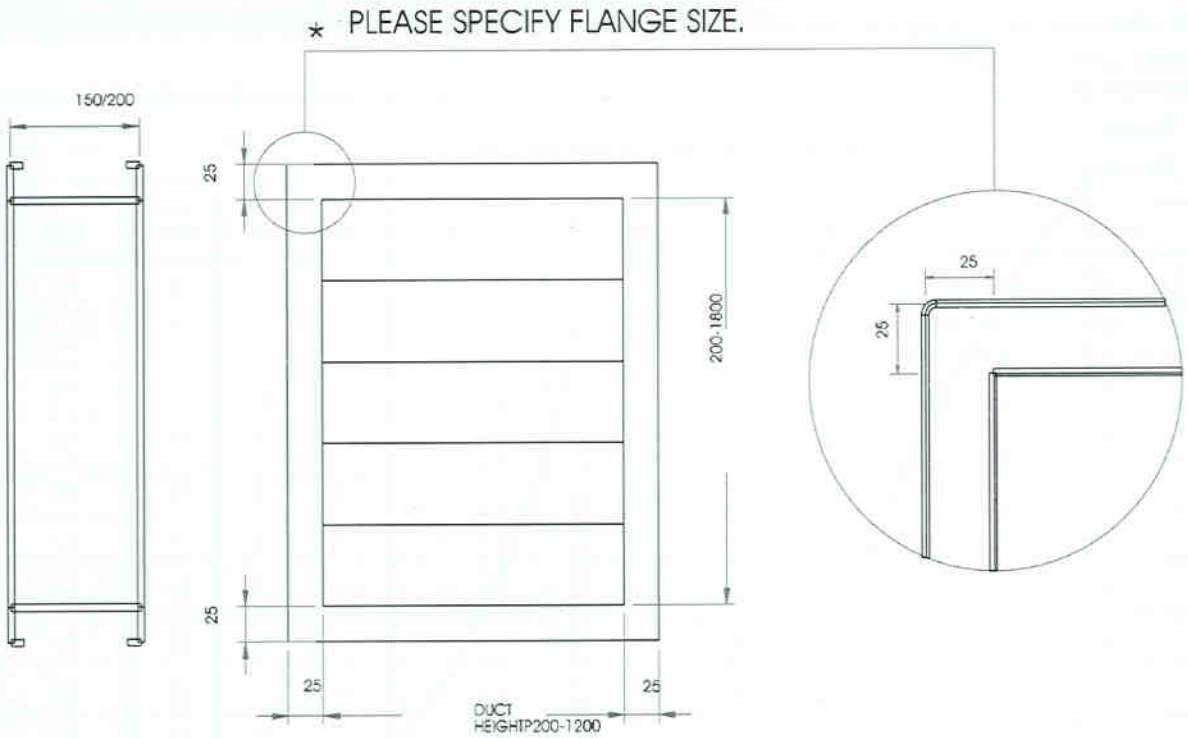

**Ordering Procedure**

Type	Frame / Case	Material	Control
CD	F25	G	H

**Frame / Case**

F 25 25 mm Flange

**Material**

- G Galvanised
- S Stainless Steel
- A Aluminium

**Control**

- H Manual Hand Quadrant
- B Extended Shaft for motorisation by others
- M Motor Factory Fitted  
(Please state type and voltage of motor separately)



**GULF MECHANICAL  
ACCOUSTIC MANUFACTURING COMPANY**

P.O. BOX: 50174 DUBAI, U.A.E. TEL: 04-3476961 FAX: 04-3476963  
Email : gmamco@emirates.net.ae